

| DIAMETER CATEGORY (mm) | MOLD NO. | ITEM NO. | DESCRIPTION | QTY / CASE PACK | CASES / PALLET | PALLET QUANTITY | RESIN TYPE | BRIMFUL CAPACITY (mL) |
|------------------------|----------|----------|-------------------|-----------------|----------------|-----------------|------------|-----------------------|
| 68 | 68175 | 224 | 175 ml | 1,000 | 30 | 30,000 | PP | 197 |
| | 88006 | 278 | 6 oz | 1,500 | 27 | 40,500 | PP | 198 |
| 73 | 73175 | 210 | 175 ml/g | 1,800 | 24 | 43,200 | PP | 200 |
| 75 | 74505 | 200 | 5.5 oz | 1,530 | 30 | 45,900 | PP | 209 |
| | 74508 | 223 | 8 oz US | 960 | 30 | 28,800 | PP | 249 |
| | 92074 | 480 | Dome Lid - 5.5 oz | 2,640 | 30 | 79,200 | PP | 54 |
| | 92174 | 460 | Dome Lid - 4.0 oz | 2,805 | 30 | 84,150 | PP | 36 |
| 79 | 86004 | 260 | 4 oz | 1,620 | 30 | 48,600 | PP | 142 |
| | 78006 | 121 | 6 oz | 1,500 | 30 | 45,000 | HDPE | 214 |
| | 78006 | 236 | 6 oz | 1,500 | 36 | 54,000 | HDPE | 214 |
| | B308C-7 | 141 | Base-7oz | 1,320 | 28 | 36,960 | PP | 253 |
| 80 | 86125 | 191 | 125 ml | 1,620 | 28 | 38,800 | PP | 170 |
| | 83175 | 183 | 175 ml | 980 | 24 | 23,520 | PP | 206 |

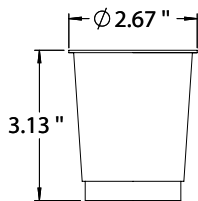

68 | 68175

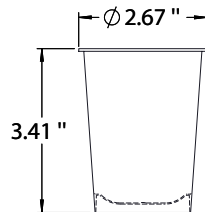

68 | 88006

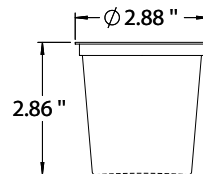

73 | 73175

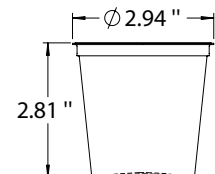

75 | 74505

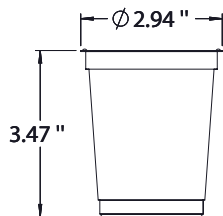

75 | 74508

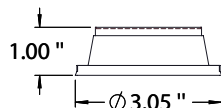

75 | 92074

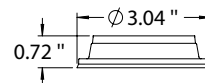

75 | 92174

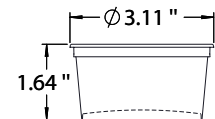

79 | 86004

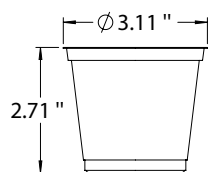

79 | 78006

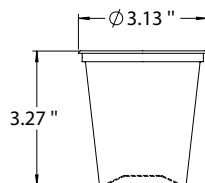

79 | B308C-7

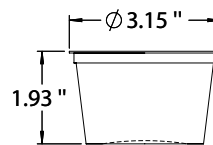

80 | 86125

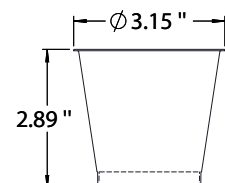

80 | 83175

| DIAMETER CATEGORY (mm) | MOLD NO. | ITEM NO. | DESCRIPTION | QTY / CASE PACK | CASES / PALLET | PALLET QUANTITY | RESIN TYPE | BRIMFUL CAPACITY |
|------------------------|----------|----------|----------------|-----------------|----------------|-----------------|------------|------------------|
| 80 | 86175 | 192 | 175 ml | 1,500 | 24 | 36,000 | PP | 220 |
| | 98008 | 467 | Flush Lid | 1,500 | 30 | 45,000 | LLDPE | |
| | 99175 | 449 | Recessed Lid | 1,500 | 30 | 45,000 | HDPE | |
| 81 | 31808 | 232 | 8 oz US - Tall | 1,000 | 30 | 30,000 | PP | 265 |
| | 97318 | 474 | Flush Lid | 1,568 | 30 | 47,040 | LDPE | |
| | 98318 | 475 | Recessed Lid | 2,200 | 27 | 59,400 | HDPE | |
| 91 | 1254 | 206 | 125 ml | 1,000 | 24 | 24,000 | PP | 220 |
| | 1250 | 108 | 250 ml | 1,000 | 18 | 18,000 | HDPE | 350 |
| | 1500R | 167 | 454 ml | 500 | 18 | 9,000 | HDPE | 540 |
| | 1500S | 142 | 500 ml | 500 | 18 | 9,000 | HDPE | 576 |
| | 992 | 416 | Dep skirt lid | 500 | 16 | 8,000 | HDPE | |
| (cont'd...) | 92600 | 461 | Dome Lid | 1,000 | 30 | 30,000 | PP | |

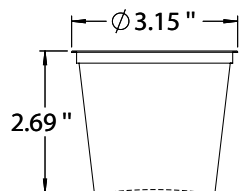

80 | 86175

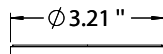

80 | 98008

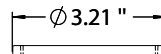

80 | 99175

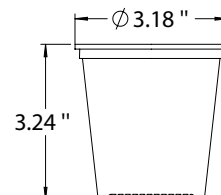

81 | 31808

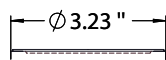

81 | 97318

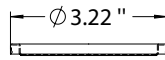

81 | 98318

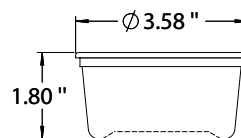

91 | 1254

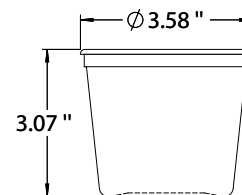

91 | 1250

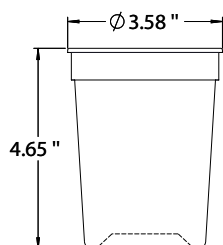

91 | 1500R

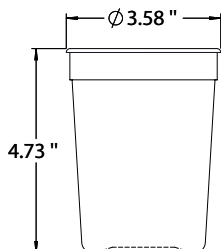

91 | 1500S

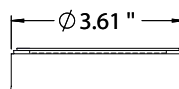

91 | 992

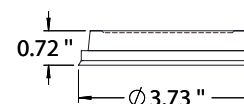

91 | 92600

| DIAMETER CATEGORY (mm) | MOLD NO. | ITEM NO. | DESCRIPTION | QTY / CASE PACK | CASES / PALLET | PALLET QUANTITY | RESIN TYPE | BRIMFUL CAPACITY |
|------------------------|----------|----------|-----------------|-----------------|----------------|-----------------|------------|------------------|
| 91 | 92 | 470 | Recessed Lid | 1,000 | 36 | 36,000 | HDPE | |
| | 92200 | 459 | Flush Lid | 1,000 | 36 | 36,000 | LLDPE | |
| 97 | 37908 | 233 | 8 oz Squat | 1,200 | 30 | 36,000 | HDPE | 290 |
| | 37916 | 237 | 16 oz Tall | 600 | 30 | 18,000 | HDPE | 537 |
| | 97379 | 476 | Flush Lid | 1,200 | 30 | 36,000 | LLDPE | |
| | 98379 | 477 | Recessed Lid | 1,500 | 30 | 45,000 | HDPE | |
| 98 | 1600 | 109 | 454 ml / 1 pint | 520 | 30 | 15,600 | HDPE | 479 |
| | 1650 | 209 | 500 ml | 460 | 30 | 13,800 | HDPE | 519 |
| | 990H | 452 | Deep Skirt Lid | 500 | 30 | 15,000 | LDPE | |
| | 990 | 413 | Deep Skirt Lid | 520 | 30 | 15,600 | HDPE | |
| 101 | 83255 | 196 | 250 ml | 864 | 24 | 20,736 | PP | 311 |
| | 83405 | 277 | 400 ml | 832 | 24 | 19,968 | PP | 457 |

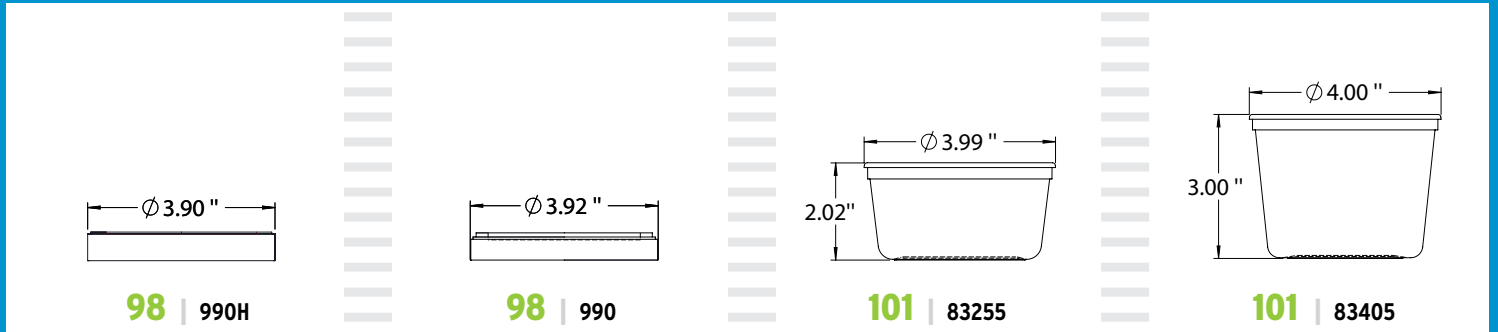
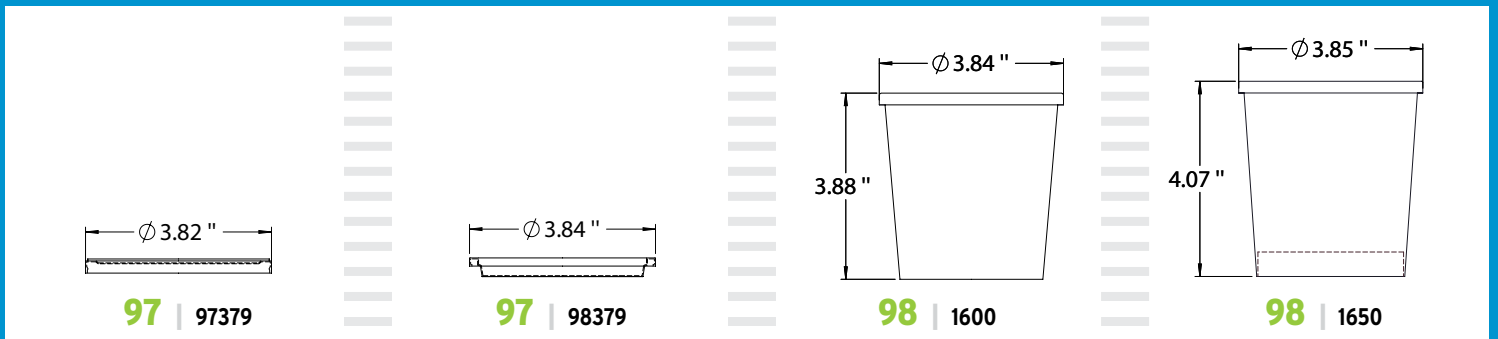
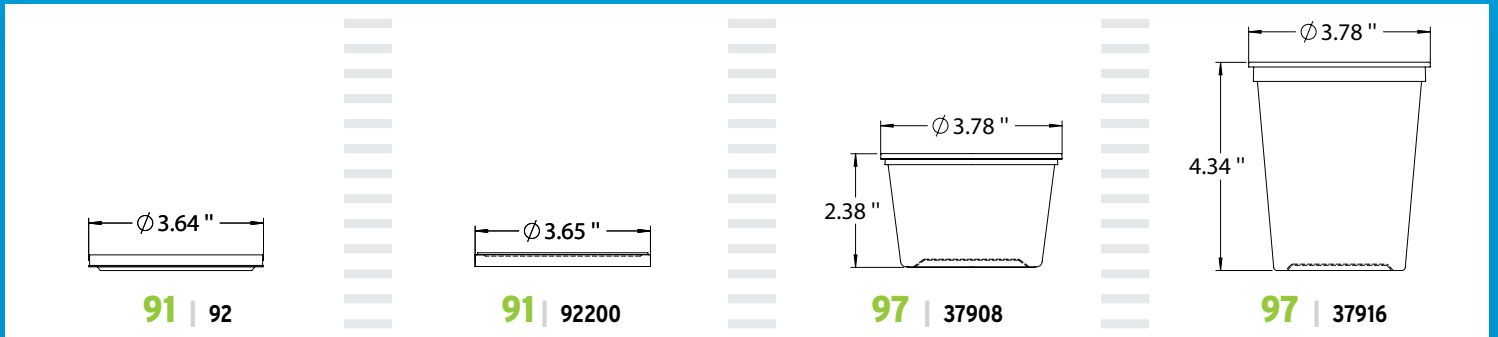

| DIAMETER CATEGORY (mm) | MOLD NO. | ITEM NO. | DESCRIPTION | QTY / CASE PACK | CASES / PALLET | PALLET QUANTITY | RESIN TYPE | BRIMFUL CAPACITY |
|------------------------|----------|----------|----------------|-----------------|----------------|-----------------|------------|------------------|
| 101 (cont'd) | 83505 | 185 | 500 ml | 768 | 24 | 18,432 | PP | 570 |
| | 93205 | 429 | Flush lid | 1,500 | 20 | 30,000 | LLDPE | |
| 115 | 8012 | 119 | 12 oz | 500 | 24 | 12,000 | HDPE | 432 |
| | 8050 | 122 | 500 ml | 500 | 27 | 13,500 | HDPE | 643 |
| | 11520 | 228 | 22 oz | 500 | 24 | 12,000 | PP | 652 |
| | 97115 | 473 | Flush lid | 1,000 | 20 | 20,000 | LDPE | |
| 116 | 11635 | 271 | 1 L | 315 | 18 | 5,670 | HDPE | 1115 |
| | 99116 | 495 | Deep skirt lid | 380 | 16 | 6,080 | LDPE | |
| 129 | 12901 | 268 | 1 lb | 600 | 30 | 18,000 | PP | 592 |
| | 70454 | 165 | 1 lb / 16 oz | 600 | 30 | 18,000 | PP | 652 |
| | 12915 | 168 | 1.5 lbs | 420 | 30 | 12,600 | PP | 925 |
| | 97454 | 440 | Flush Lid | 600 | 36 | 21,600 | LLDPE | |

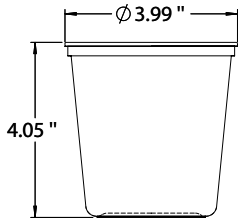

101 | 83505

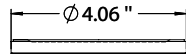

101 | 93205

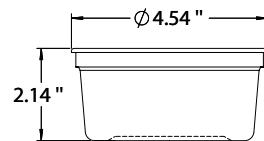

115 | 8012

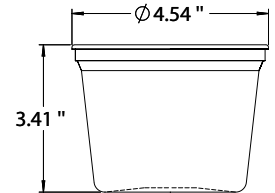

115 | 8050

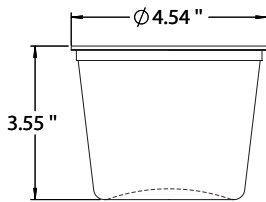

115 | 11520

115 | 97115

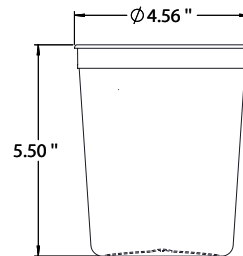

116 | 11635

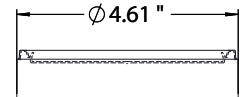

116 | 99116

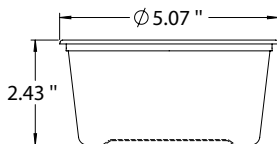

129 | 12901

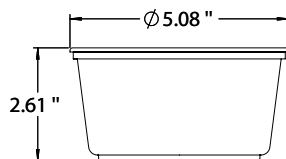

129 | 70454

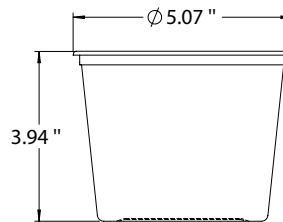

129 | 12915

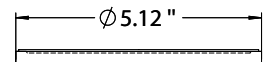

129 | 97454

| DIAMETER CATEGORY (mm) | MOLD NO. | ITEM NO. | DESCRIPTION | QTY / CASE PACK | CASES / PALLET | PALLET QUANTITY | RESIN TYPE | BRIMFUL CAPACITY |
|------------------------|----------|----------|-----------------|-----------------|----------------|-----------------|------------|------------------|
| 140 | 14001 | 123 | 1 L | 312 | 16 | 4992 | HDPE | 1141 |
| | 99140 | 414 | Deep Skirt Lid | 312 | 16 | 4992 | LDPE | |
| 156 | 15602 | 269 | 1 ltr / 2 lb | 480 | 20 | 9600 | PP | 1146 |
| | 15616 | 177 | 1.4 L / 2.8 lbs | 312 | 20 | 6240 | PP | 1651 |
| | 15603 | 270 | 1.5 ltr / 3 lb | 312 | 20 | 6240 | HDPE | 1700 |
| | 15619 | 101 | 1.89 L | 272 | 18 | 4896 | HDPE | 1891 |
| | 15604 | 105 | 2 ltr / 4 lb | 232 | 18 | 4176 | HDPE | 2175 |
| | 15605 | 280A | 2.5 ltr / 5 lb | 168 | 24 | 4032 | HDPE | 2640 |
| | 98907 | 446 | Flush Lid | 480 | 20 | 9600 | LLDPE | |
| | 98020 | 421 | Recessed Lid | 480 | 24 | 11520 | LLDPE | |
| | 994 | 418 | Deep Skirt Lid | 200 | 16 | 3200 | HDPE | |
| | 99156 | 496 | Deep Skirt Lid | 209 | 20 | 4180 | LDPE | |

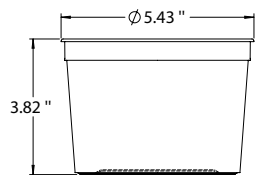

140 | 14001

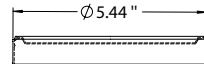

140 | 99140

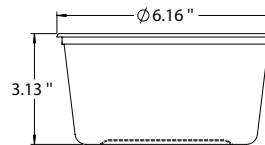

156 | 15602

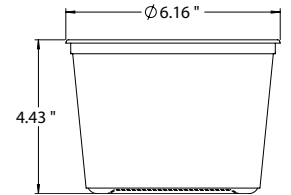

156 | 15616

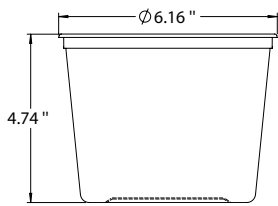

156 | 15603

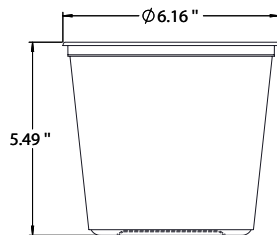

156 | 15619

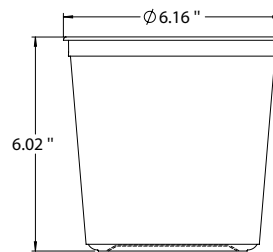

156 | 15604

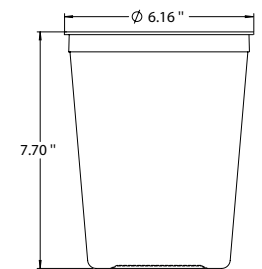

156 | 15605

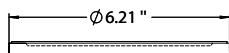

156 | 98907

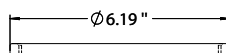

156 | 98020

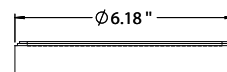

156 | 994

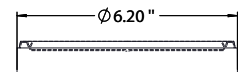

156 | 99156

| DIAMETER CATEGORY (mm) | MOLD NO. | ITEM NO. | DESCRIPTION | QTY / CASE PACK | CASES / PALLET | PALLET QUANTITY | RESIN TYPE | BRIMFUL CAPACITY |
|------------------------|----------|----------|---------------------|-----------------|----------------|-----------------|------------|------------------|
| 170 | 2000 | 213 | 2 L | 150 | 20 | 3000 | HDPE | 2230 |
| | 16602 | 215 | 4 lb / 2 ltr. squat | 152 | 20 | 3040 | HDPE | 2239 |
| | 90170 | 472 | Flush Lid | 180 | 36 | 6480 | LLDPE | |
| | 99166 | 423 | Deep Skirt Lid | 150 | 28 | 4200 | LDPE | |
| 210 | 82040 | 179 | 4 ltr | 100 | 12 | 1200 | HDPE | 4370 |
| | 399 | 481 | Flush | 120 | 36 | 4320 | LLDPE | |

