



B1000

OPERATION MANUAL | SPARE PARTS LIST

BATTERY POWERED PLASTIC STRAPPING TOOL



CE

READ ALL INSTRUCTIONS BEFORE OPERATING THE TOOL

POLYCHEM CORPORATION
6277 HEISLEY ROAD, MENTOR, OHIO 44060
PHONE: 440.357.1500, FAX: 440.352.9553
WWW.POLYCHEM.COM

ED.06/17

TABLE OF CONTENTS

- 1) Safety instructions
- 2) Technical data
- 3) Warranty and liability
- 4) Installation-accessories
- 5) Operating elements / adjustments
- 6) Operation
- 7) Servicing and cleaning
- 8) Troubleshooting
- 9) Layout – spare parts list

1) SAFETY INSTRUCTIONS



READ THE OPERATING INSTRUCTIONS CAREFULLY



WEAR EYE, FACE, AND HAND PROTECTION WHEN OPERATING THE TOOL.



GENERAL SAFETY INSTRUCTIONS:

The tool must be used by properly trained people. Failure to follow the operating instructions or improper use could cause strap breakage, injuries, or package damages.

Check tool daily, do not use tool with worn or damaged parts. Use original spare parts for replacement. Never modify any tool part.

Do not put fingers, hands or other body parts between the strap and package during the cycle.

It is your responsibility to check the seal joints made by your tool. Training about the weld time adjustment will be useful to check the seal quality in order to avoid severe injury. Never move goods with bad quality seals. Only use specific strap dispenser to dispense the strap. Keep your working area clean and always use the tool in good balance and safety conditions. Never use straps as a means of pulling or lifting goods.

Always use a proper safety strap cutter and keep other people and yourself at a safe distance from strap, always stand to side of strap, away from direction of strap trajectory once cut. Hold the upper strap portion and pay attention that the lower strap will snap forward away from you.

Improper operation, excessive tensioning, use of non-recommended strap, or sharp corners on the package could cause a loss of strap tension and/or strap breakage that could lead to packaging failure or injury. The following is recommended; use edge protectors if package has sharp corners, place the strap correctly around a properly positioned package, stand in safety position (on one side of strap) during strapping cycle, and use the correct strap quality, width, thickness, and break strength as recommended in this manual.

Please save this manual, as it is a part of the tool. This tool is manufactured without any substances which could be dangerous to health. National instructions must be observed for disposal of all the parts.

2) TECHNICAL DATA

TOOL SIZE		
Length:		12.4"
Width:		5.5"
Height:		7.2"
Weight with battery:		8.4 lbs.

POWER REQUIREMENT		
Battery		14.8V - 3A/h LI-PO

PERFORMANCES		
Max.Tension force:		5000N
Tensioning speed:		12mt/m
Sealing:		Friction weld seal
Joint strength:		80% plastic strap strength*
Level sound emission. Measurement type A (2003/10/CE)		81 dB (A)
Vibrations at handle (2002/44/CE)		2.2 ms ²

* depends of strap quality

Working temperature: The tool should be used between 0C° (32F) and +45C° (+113 F). When using in low temperatures the display may signal low battery. In this case insert the battery for 2 mins. in charger for a "refreshing".

CHART OF TYPES

ITEM	MODEL	STRAP	THICKNESS
T239997	B1000 - 5/8"-3/4"	PET - 5/8"	0.041"
		PET - 3/4"	0.031" - 0.050

3) WARRANTY CONDITIONS AND LIABILITY

Polychem Corporation warrants all its tools and battery chargers during a period of 6 months from the shipping date document. Wear parts are warranted for 45 days, otherwise wear parts are excluded from regular warranty, wear parts are shown on spare parts list (in tool manual).

Warranty includes free replacement parts. The warranty is not valid in case of improper use, lack of maintenance, tampering, arbitrary modifications and reparations, use of non-original parts, disregard of instructions of the operation manual, or missing serial number. No compensation can be claimed for production shutdowns and for damages to people and objects due to tool defects. Polychem Corporation reserves the right to modify the tools and documentation without any obligation to update previous ones. Polychem warrants all its batteries during a period of 120 days from the shipping date document. The manufacturer is committed to replace it with a free battery only when there are manufacturing defects that make it unfit for use.

4) INSTALLATION / ACCESSORIES

The LI-PO (Lithium-Polymer) battery comes fully charged. In order to begin, insert the battery in the tool until it locks in place with the security lever. Illustrated in the following figure:



SECURITY LEVER

TOOL ACCESSORIES

IT IS RECOMMENDED TO ONLY USE POLYCHEM ACCESSORIES

BATTERY:

SAFETY INSTRUCTIONS: Only use the battery for our strapping tool and only recharge it with our battery charger. If used for other purposes or applications our warranty will be void. Failure to follow the operating instructions or improper use could cause injuries and battery damage.

The battery is supplied fully charged. The lithium polymer rechargeable battery can be charged at any time without reducing its service life; interrupting the charging procedure does not cause damage. To use and charge the battery, please follow the operating instructions.

Check battery daily; do not use it with worn or damaged parts.

Do not disassemble it, never modify any part, do not connect the positive (+) and negative (-), it may result in a short circuit. Do not transport or store the battery with metal objects. Do not try to charge it with a different charger. Do not put metal keys between contacts. Do not use the battery for purposes other than those specified.

Battery must not be left in charging mode without supervision.

Do not throw the battery into a fire, do not store at high temperature or direct sunlight, and do not put in microwave oven or a pressure cooker. Keep it away from any exposed flame. Do not dip the battery in water, and protect it from humidity. Do not apply impact to the battery, or throw, drop, drill it. In case of smoke or fire immediately stop using it and replace it.

In case electrolyte comes into contact with eyes or hands, immediately rinse thoroughly with clean water and consult a physician.

The battery must be recycled or disposed of in an environmentally friendly way. Defective or dead batteries must be recycled according to national / local guidelines.

TECHNICAL DATA : Li-Po (Lithium-Polymer) 14.8V – 3.0 Ah Weight : **1 lb.** Part # - **B800BAT**
Charge time is 30 min. Operating environment charging and discharging: **0C° (32F) and +45C° (+113 F)**



SERIAL NUMBER

BATTERY CHARGER:

SAFETY INSTRUCTIONS: Only use the charger to charge our lithium polymer battery. If used for other purposes or applications the warranty and liability is void. The charger should be used by properly trained people. Failure to follow the operating instructions or improper use could result in injuries or battery damage. Check charger and main supply cable daily; do not use it with worn or damaged parts. Do not disassemble it or modify any part. Check the contacts before using. Do not put metal keys between contacts. Do not use for purposes other than those specified. **BATTERY MUST NOT BE LEFT IN CHARGING MODE WITHOUT SUPERVISION.** Do not store at high temperature, direct sunlight, do not cover fan clefts. Do not dip it in water and protect from humidity. Do not apply impact, or throw or drop or drill it. In case of fire or smoke immediately stop using and replace it. Place the charger on flat, non-flammable and heat resistant surface. Keep away from any volatile and flammable substance. Disconnect from main power supply when not in use. Service should be done by authorized dealers. The Charger must be recycled or disposed of in an environmentally friendly way according to the national / local guidelines.

CHARGING PROCESS: Put the battery into the charger correctly (do not invert the polarity), the charge will start automatically and the signaling led becomes RED. It will remain in this condition up to 80% of the charge then the signaling led will become blinking GREEN, this indicates the charge is 80% to 99% complete. The charging process is complete when the signaling led is solid GREEN; remove the battery from charger.

FAILURE: If the signaling led is blinking RED it indicates that the temperature of the battery is not sufficient for charging or its voltage is lower than 10.4V and therefore the battery will not charge. Let the battery return to normal temperature and try again. If the charge does not start contact the service center.

TECHNICAL DATA: PART # - 400CHG Input : 110V - 230V – 50/60Hz – 80W Output : 16V – 5A

ATTENTION: This battery charger is only used with Li-Po 14.8V batteries.



NOTE: REMOVE THE BATTERY FROM THE CHARGER ONCE THE CHARGE IS COMPLETE.



LED OF SIGNALLING

RED LED: BATTERY CHARGING – LEVEL 0 TO 80%

BLINKING GREEN LED: BATTERY CHARGING – LEVEL 80% TO 99%

GREEN LED: CHARGE COMPLETE

BLINKING RED LED: BATTERY DEFECTIVE / DAMAGED

WEARING PLATE:

The tool can be equipped with a stainless steel plate to protect the base against excessive wear when using it on abrasive surfaces like bricks, concrete, stones, etc ... The part number for the kit is 401-0251.

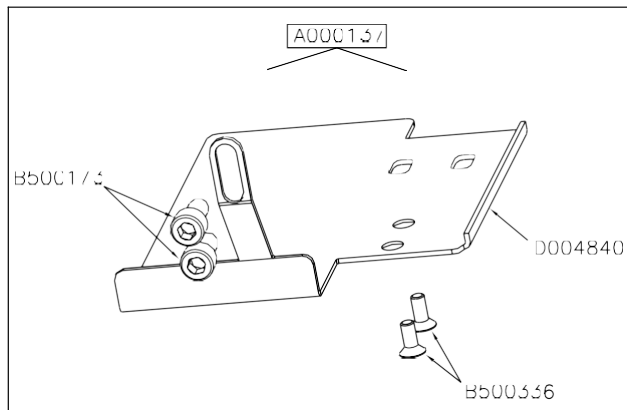

SUSPENSION HOOK:

The tool can be equipped with a two position suspension hook (horizontal or vertical). The hook is fixed to the tool by two screws (see picture below). The part number for the hook is 401-2130.

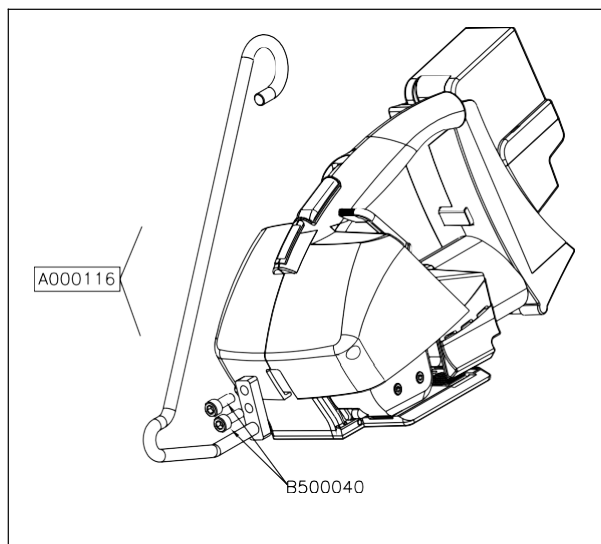

5) OPERATING ELEMENTS AND ADJUSTMENTS

DO **NOT** OPERATE THE TOOL WITHOUT STRAP, YOU COULD DAMAGE THE FEEDWHEEL AND THE WELDING / CUTTING GROUP

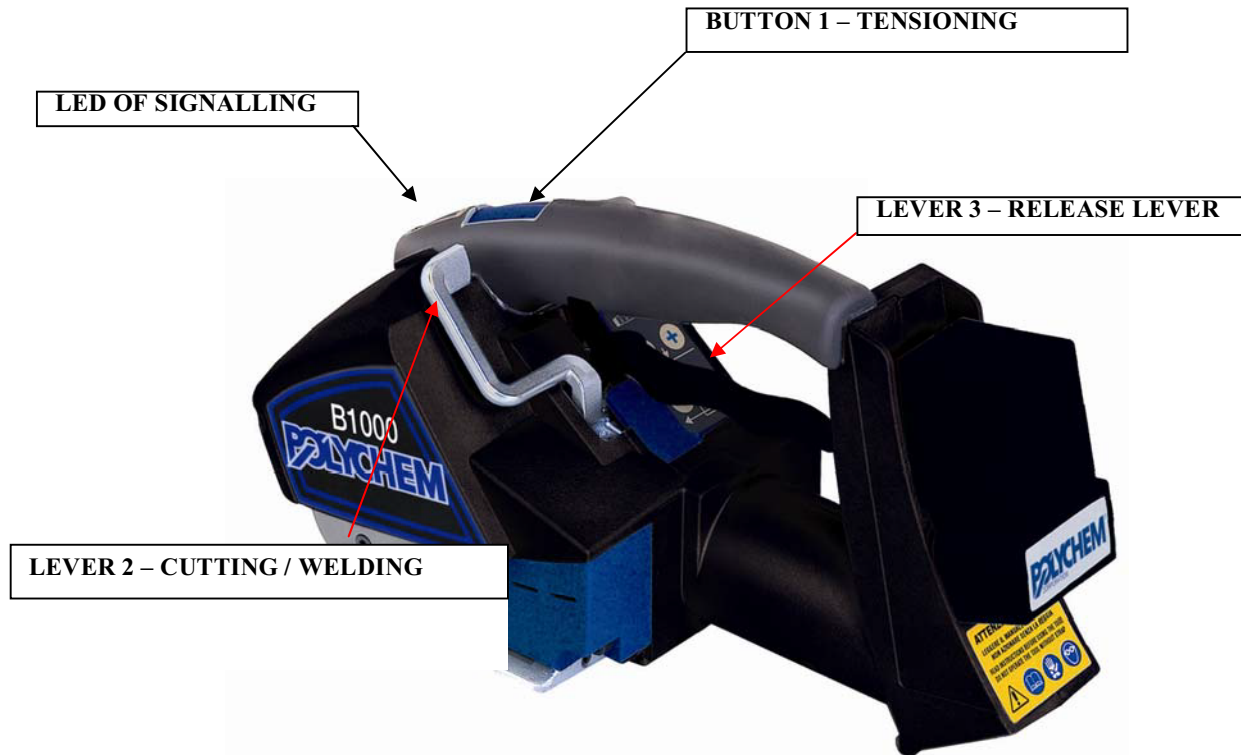

LED OF SIGNALLING	
AMBER	TOOL IN OPERATION
AMBER BLINKING	TOOL IN STAND-BY

Programming (pic. A):

In order to make adjustments (welding/cut and tension) first push the tension button with the feed wheel open to activate the board. Then at the same time press the S+ (Welding) and T+ (Tension) keys for approximately 10 sec. like illustrated in pic. A. This will illuminate the LED that indicates the value of the welding time, in order to switch to the tension adjustment you must press the T+ or T- key.

Welding - cutting time adjustment (pic. B):

The welding/cut time can be adjusted by pressing on the S+ or S – key depending on the quality and the dimensions of the strap. Pressing the + key will increase the welding time, pressing the – key will decrease the welding time. After 10 sec. the data will be stored into the memory of the card.

Adjusting strap tension (pic. C) :

The tension of the strap can be adjusted by pressing on the T+ or T – key depending on the quality and the dimensions of the strap. Pressing the + key will increase the tension level, pressing the – key will decrease the tension level. After 10 sec. the data will be stored into the memory of the card.

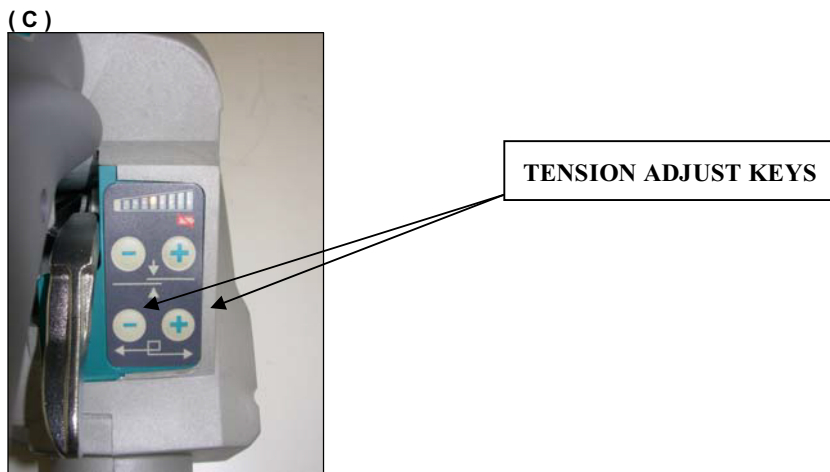
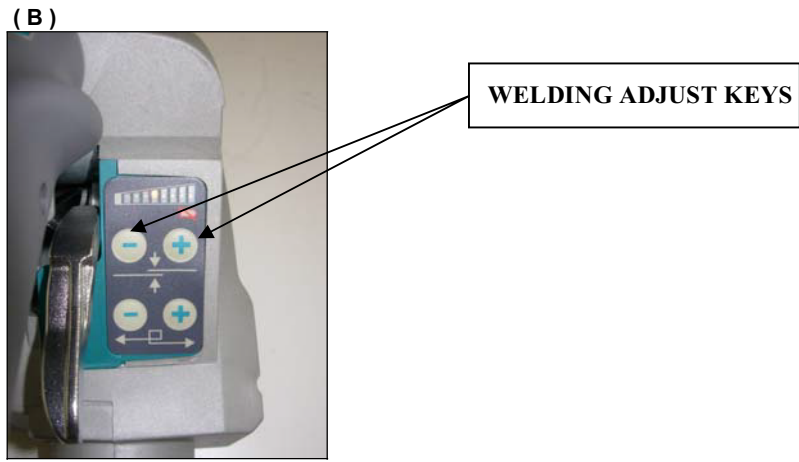

Adjusting welding area:

Adjust the screws for uneven welds(pic.E1-E2).If the weld is mostly on the external strap side (pic.E3) slightly unscrew the external screw or slightly screw in the internal screw for a uniform weld(pic.E4). If weld is mostly on the internal strap side (pic.E5) slightly unscrew the internal screw or slightly screw in the external screw for a uniform weld(pic.E6).

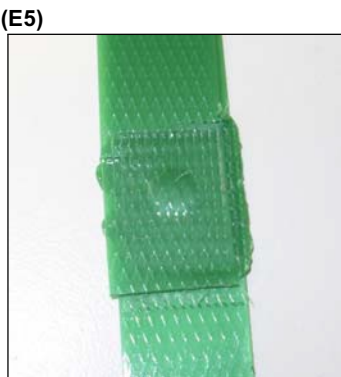
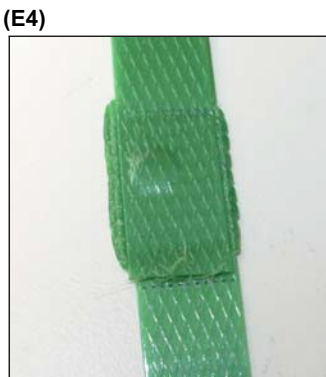
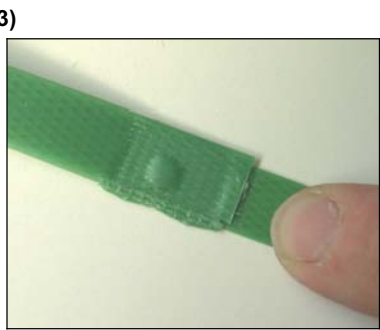
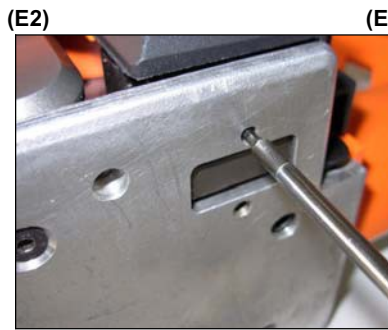
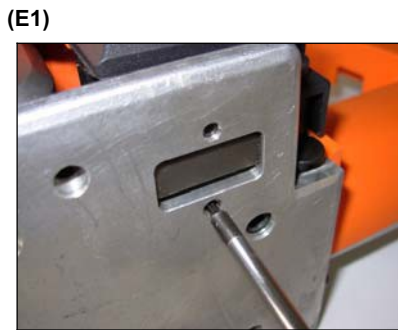

6) OPERATION

Put the strap around the package as shown (fig. F1). Overlap the straps with the lead end on the bottom and hold the straps in left hand (make sure the strap is clean, & oil & grease free); to open the tool squeeze the release lever. Insert the straps in the tool making sure they are overlapped and aligned against the strap guides (fig. F1). Press the tension button to start tensioning, when the desired tension is obtained release the button (After reaching tension the tension button can be depressed up to 3 more times before the welding must be initiated) (fig. F2). To start the welding, pull the welding lever. The tool will now weld and cut the strap and cool the weld (fig. F3). **AFTER** the amber LED lights up and the ringing sound of the tool that indicates the end of the welding cycle, it is possible to remove the strap (fig. F4). Damage may be caused to the tool and strap if the tool is opened before the ringing sound is made. After welding, the LED on the keypad shows the level of the battery charge remaining. Example: charged battery (fig. F5) – battery nearly discharged with approximately 2 cycles left (fig. F6). The last 2 bars on the right indicate the battery is discharged (fig. F7). To replace the battery or to recharge the same one, remove the battery from the tool by depressing the release key and pulling the battery upwards (fig. F8).

(F1)

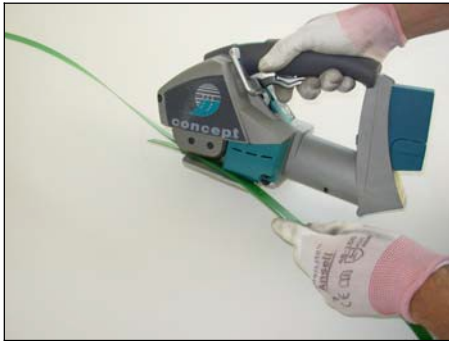

(F2)



(F3)



(F4)



(F5)



(F6)



(F7)



(F8)



Seal check:

A regular seal quality control is very important and it can be examined visually as follows:

G1) short sealing time/ not enough

G2) right sealing time/ correct

G3) too long sealing time/ wrong

(G1)

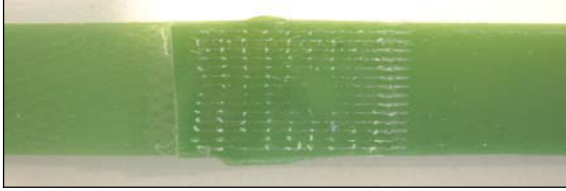

NO – seal strength insufficient

(G2)

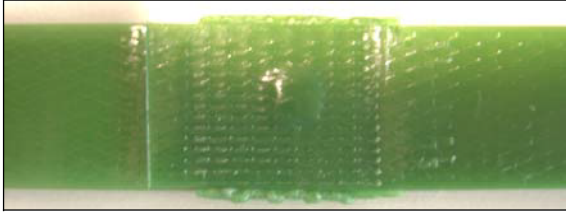

Yes -- right

(G3)

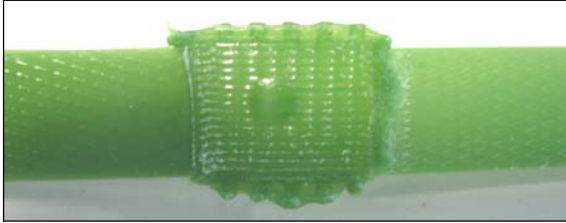

NO – seal strength affected

7) SERVICING - CLEANING

BEFORE PERFORMING ANY SERVICE ON THE TOOL, REMOVE THE BATTERY FROM THE TOOL

Periodically clean the tool from strap dust, particularly the feed wheel, the gripper plates and the cutter by using compressed air.

Bottom plate gripper replacement

To change the gripper plate, continue as follows:

Remove front strap guide (fig. **H1**), remove two gripper screws (fig. **H2**), remove the gripper plate (fig. **H3**). Install new gripper plate and reassemble in reverse order.

(H1)



(H2)



(H3)



Welding foot replacement

To change the welding foot, continue as follows:

Remove screw and cover (pic. **L1**), remove the oscillating foot pin (pic. **L2**) remove the foot with the aid of one clamp and replace it (pic. **L3**). Reassemble in reverse order.

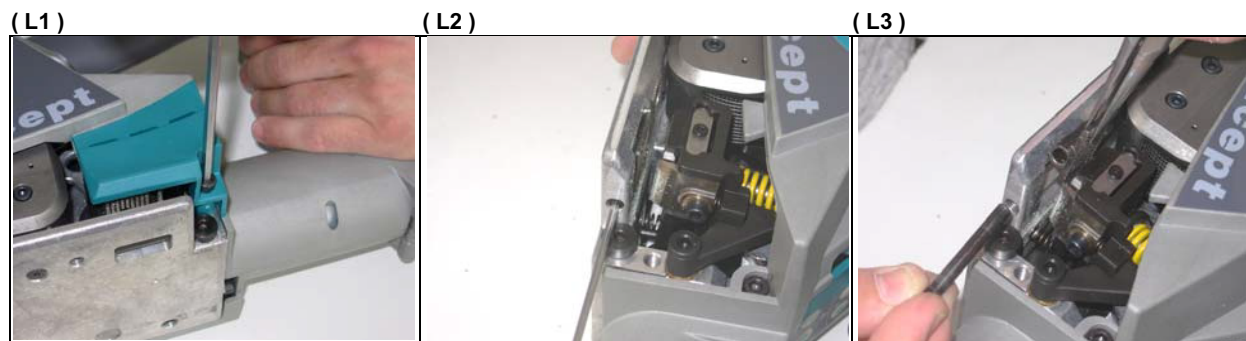

8) TROUBLESHOOTING

PROBLEM
REMEDY
After inserting the battery and pushing the tension button the tool doesn't work
Check the battery contacts in the rear of the tool and / or if there are disconnected wires Check the microswitch under the push button – check the battery charge status (led lights on keyboard)
The tension of the strap is too low on the package
Check tension value on keypad; Check the battery charge / efficiency Check if the tension motor is damaged or worn out (contact the after sale service) Check the gearbox (contact the after sale service) Check the electronic card (contact the after sale service)
The feedwheel slips and mills strap
Check if the feedwheel and grippers are dirty or damaged. Adjust the motor power—too much tension force. Check if the strap qualities are right for the strapping tool and application
The strap is breaking during tension
Adjust the tension—it may be too high. Check if the strap qualities are right for the strapping tool and application. Check for sharp edges on the package.
The seal is not aligned
Adjust the motor power—too much tension force. Check if the strap qualities are right for the strapping tool and application. Check strap size and adjust the guides. Check the alignment.
The lower strap isn't locked between the gripper and feedwheel so the tool walks during the tension
Check if the gripper is dirty or damaged. Adjust the tension value for the quality of strap.
Tensioning problem—the strap relaxes after tensioning
Check for damage to feed wheel or the locking mechanism (contact the after sale service)

The sealing isn't enough; the upper strap isn't completely cut; the cutting isn't constant
<p>Check the sealing time, may be too short, adjust it on keypad</p> <p>Check if the sealing foot and / or the cutter are damaged or worn out — perform maintenance</p> <p>Check if the sealing foot is dirty or slips on strap</p> <p>Check if the strap relaxes after tensioning</p> <p>Check the battery charge / efficiency</p> <p>Check if the strap qualities are right for the strapping tool and application</p> <p>Check if the sealing motor is worn out (contact the after sale service)</p> <p>Check the electronic cards (contact the after sale service)</p>
Too much seal time; the strap is breaking during the sealing - cutting
<p>Improper weld timing adjustment, may be too long, adjust it.</p>
Both straps are cut during the sealing cycle
<p>Check if the gripper plate (under the sealing foot) is dirty or damaged (clean or replace it)</p> <p>Check if the strap is over tensioned. Improper weld time adjustment, may be too long, adjust it.</p>
The motor doesn't start when the sealing lever is activated
<p>Check if the welding start microswitch is worn out, or the welding cam doesn't touch the switch.</p>
After the cycle it is impossible to remove the tool from the package and the opening lever is too hard to move
<p>Check if the opening group is working or is locked (when you squeeze the opening lever the strap tension should be released) (contact the after sale service)</p> <p>Check the gearbox (contact the after sale service)</p> <p>Check if there are some defective parts in the opening lever group and / or mechanical obstructions.</p>
It is difficult to adjust the tension or welding time, doesn't stay consistent
<p>There are probably keyboard or electronic card problems / (contact after sale service)</p>
Progressive problems with the battery life
<p>Check the battery charge, try to recharge and check if the battery charger is working properly.</p> <p>May be that the battery is at the recharge limit.</p> <p>May be that the internal cells are damaged or worn out.</p> <p>Test tool with a different battery</p>
The charger will not start to recharge the battery
<p>The battery is damaged- do not use</p> <p>The battery voltage is lower than 10V – check by electric tester; Check if the charger is still running.</p>

9) LAYOUT-SPARE PARTS LIST

Ed. 06/17

POLYCHEM PART #	ITEM	DESCRIPTION	QNTY		
190169	A000142	TENSION MOTOR GROUP	1		*
190025	A000097	SIGNALS CARD WITH LIGHT TRANSP	1		*
B800BAT	A000115	BATTERY 3A/h	1	§	*
189980	A000237	EXCENTRIC SHAFT ASSEMBLED	1		
190166	A000238	WELDING MOTOR ASSEMBLED	1		*
190026	B400186	BEARING 61808-RS1	2		
190028	B400188	FREWHEEL INA HF0812	1		
190029	B400332	BEARING 609 ZZ SKF	1		
190030	B400333	BEARING 61902 ZZ	2		
190031	B500035	SCREW M4X10	9		
190032	B500036	SCREW M5X12	5		
190161	B500068	SCREW M3X8 UNI 5931	1		
190036	B500140	SCREW M5X30	1		
190037	B500158	SCREW M4X12	3		
190038	B500208	SCREW BN13577 3,5X20 KA35	4		
190147	B500211	LOCK. WASHER	4		
190039	B500214	SCREW M4X8	2		
190040	B500273	SCREW M3X10	6		
190041	B500275	SCREW M2X10	2		
190042	B500281	SELFLOCK. NUT M6 D985 5S	1		
190043	B500336	SCREW M4X10	2		
190044	B500379	SCREW M4X5	5		
190045	B500384	SCREW 2.9X4.5	2		
190046	B500385	SCREW 2.9X6.5	3		
190047	B500395	SCREW 3.5X16	3		*
190033	B500418	SCREW TCEI UNC10-24X3/8" B18.3	4		
190049	B600018	WASHER PS 10x5x0,3	1		
190050	B600112	WASHER PS12X18X0.5 DIN988	2		
190052	B600159	CIRCLIP A12 DIN471	2		
190053	B600189	CIRCLIP RA3.2 DIN6799	1		
190054	B600190	CIRCLIP D8 7435	2		
190134	B600227	CUP WASHER CB12.5X6.2X0.7 D.2093	1		
190057	B600343	SPRING G13-025 ISO10243	1		
190059	B600345	CIRCLIP D34 UNI 7435	1		
190060	B600346	CIRCLIP D15 UNI7435 R150	1		
190061	B600376	WASHER PS 15X21X0.5	1		
190075	B600391	WASHER PS 6X21X0.2	1		
190062	B700076	PIN 4X12 DIN6325	1		
190063	B700101	PIN 6X28 DIN6325	1		
190143	B700103	ELASTIC PIN 3x10 UNI6873	1		
190064	B700325	SPHERE DIAM.5mm	8		
190066	B800366	KEYBOARD	1		*
190067	B800378	WELDING MICROSWITCH	1		*
190068	B800396	TENSION MICROSWITCH	1		*
190170	B800441	POWER CABLES KIT	1		
190171	B800450	ELECTRONIC POWER CARD	1		*
190070	D000010	PIN	1		
190071	D000170	GEAR SHAFT	1		
190073	D000250	STRAP LOCKER	1	§	*

POLYCHEM PART #	ITEM	DESCRIPTION	QNTY		
190117	D000280	REAR STRAP GUIDE SPRING	1		
190074	D000330	FREEWHEEL SUPPORT	1		
190076	D000390	LOCKING COVER	1		
190077	D000400	GEAR	1		
190079	D001140	TENSION SPRING	1		
190122	D001420	SPECIAL SCREW M4x10	3		
190081	D002020	WELDING FOOT PIN	1		
190082	D002030	FLANGE	1		
190083	D002040	CONNECTING ROD	1		
190087	D002080	SPRING SUPPORT	1		
190091	D002130	CUTTER GUIDE	1		
190092	D002140	COVER	1		
190022	D002150	FEED WHEEL SUPPORT	1		
190135	D002170	LEVER SUPPORT	1		
190023	D002160	MOTOR FLANGE	1		
190093	D002180	SHAFT	1		
190094	D002190	HOOK	1		
190095	D002200	OPENING LEVER	1		
190096	D002220	WELDING MOTOR FLANGE	1		
190098	D002240	SPRING PIN	1		
190099	D002250	SPRING SUPPORT	1		
190100	D002260	SUPPORT PIN	1		
190102	D002280	WELDING LEVER PIN	1		
190104	D002300	WELDING GROUP SPRING	1		*
190110	D002990	BATTERY RELEASE / CUTTER SPRING	2		*
190172	D005760	RIGHT COVER (BLACK)	1		
190173	D005770	LEFT COVER (BLACK)	1		
190115	D004270	TENSION BUTTON SPRING	1		*
190123	D004540	WELDING FOOT	1	§	*
190163	D004550	TENSION MOTOR PROTECTION	1		
190145	D004560	OPENING LEVER SPRING SCREW	1		
190124	D004600	WELDING PLATE	1	§	*
190126	D004620	CUTTER	1	§	*
190136	D004630	FRONT STRAP GUIDE	1		
190158	D004640	SUPPORT	1		
190137	D004650	SUPPORT WELDING FOOT	1		
190138	D004660	REAR GUIDE STRAP	1		
189979	D004670	CENTERING RING FOR WELDING MOTOR	1		
190174	D005810	BATTERY RELEASE LEVER (BLUE)	1		
190175	D005800	TENSION BUTTON (BLUE)	1		
190176	D005790	KEYBOARD SUPPORT (BLUE)	1		
190177	D005780	BLADE COVER (BLUE)	1		
190178	D005540	FEEDWHEEL	1	§	*
190179	D005550	EPICICLOIDAL GEARBOX	1		
190168	D005260	WELDING LEVER	1		
190167	D005270	LINKER	1		
		§	WEARING PART		
		*	PART THAT SHOUD BE STOCKED		

B1000

- LOCTITE 268
- LOCTITE 243
- ⊕ SKF LGMT 2
- ✕ NON FORNIBILE SINGOLARMENTE
NOT SUPPLIED ALONE

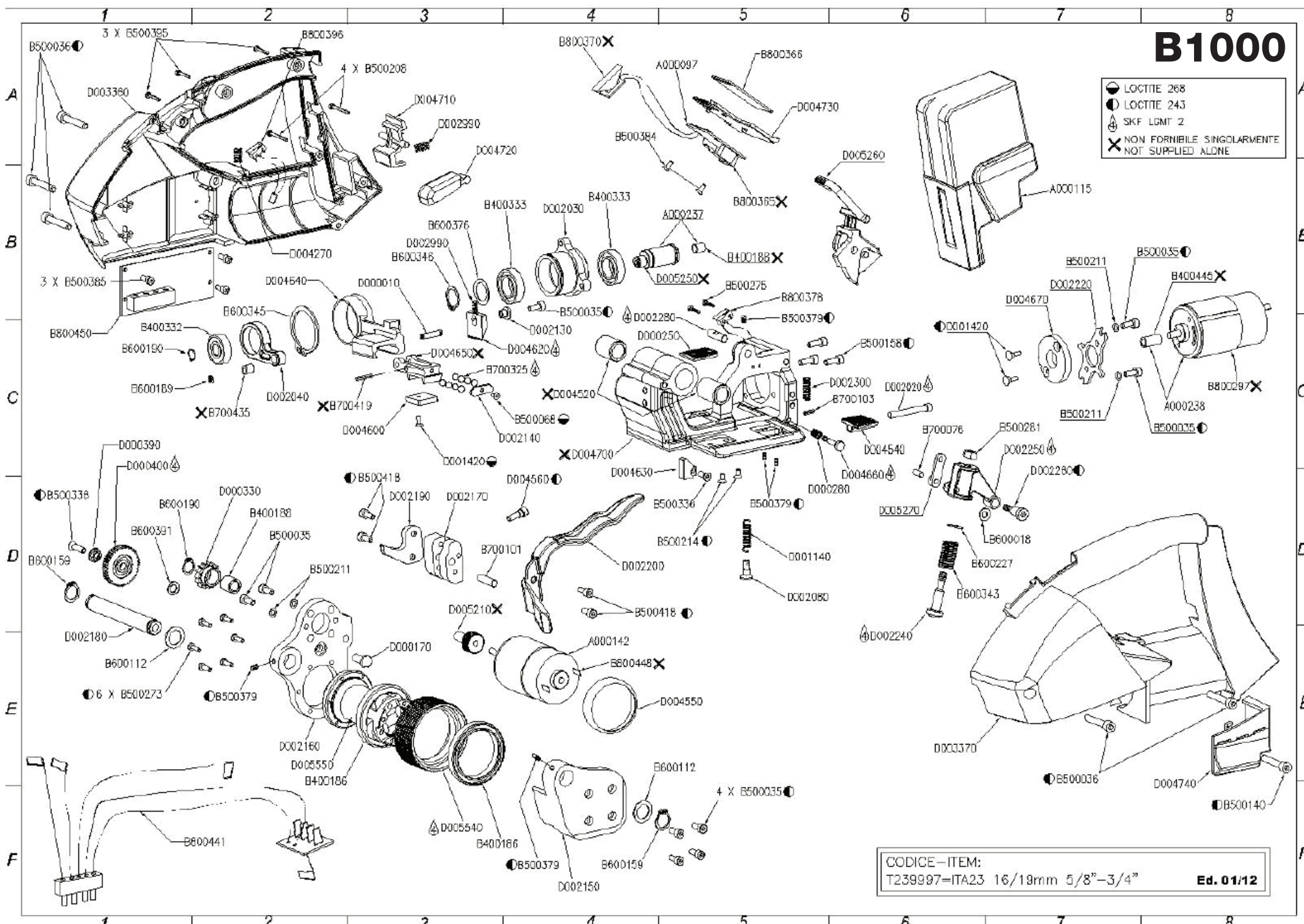

CODICE - ITEM:
T239997=ITA23 16/18mm 5/8"-3/4"
Ed. 01/12

CE DECLARATION OF CONFORMITY

POLYCHEM declares under own responsibility that the under mentioned machinery, to which this declarations refers, is in conformity with **CEE 98/37** Directive and successive modifications, as well as with standards **EN60745-1, EN60745-2-18, EN55014-1, EN55014-2, EN61000-3-2, EN61000-3-3**

MODEL:

**Series
B1000**



MACHINE TYPE:

BATTERY POWERED PLASTIC STRAPPING TOOL

POLYCHEM CORPORATION

6277 Heisley Road Mentor, Ohio 44060

Tel.: 440-357-1500 Fax: 440-352-9553 www.polychem.com

